

Installation Guide

Case/room controller (EEV)
Type **AK-CC55 Single Coil**



084R8053



AN294432763974en-000501

Identification

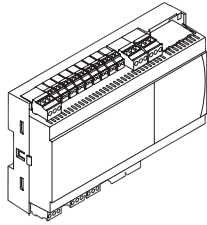

084B4082

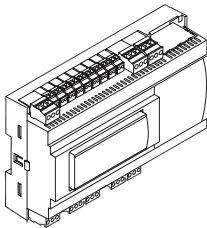

084B4083

Dimensions

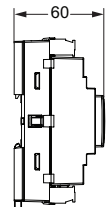
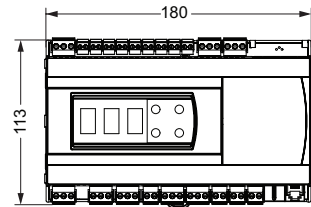
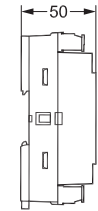
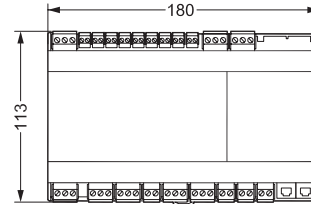

Principle

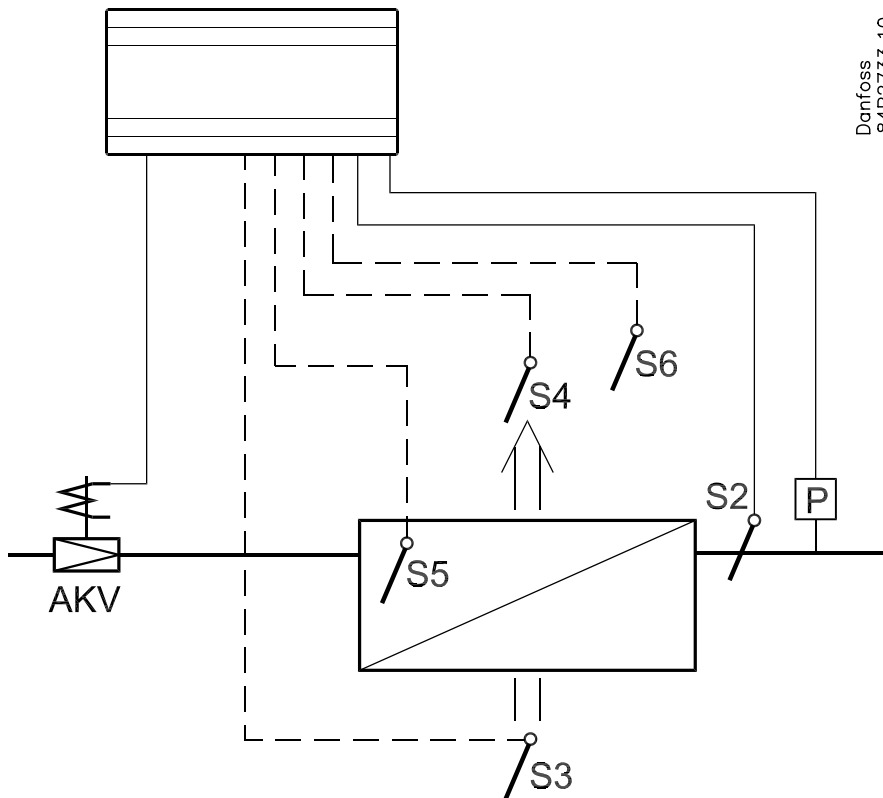

Danfoss
84B2733:10

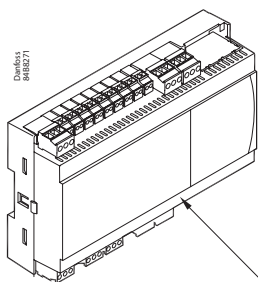

1	~~~~~
2	~~~~~
3	~~~~~
4	~~~~~
5	~~~~~
6	~~~~~
7	~~~~~
8	~~~~~

The controller is provided with labels from the factory indicating a generic application. When selecting the required application, specific labels are provided so that you can mount the relevant one.

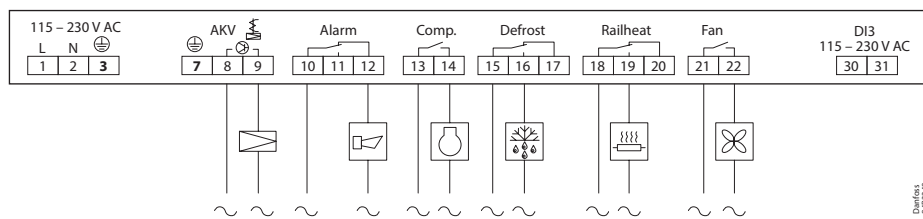
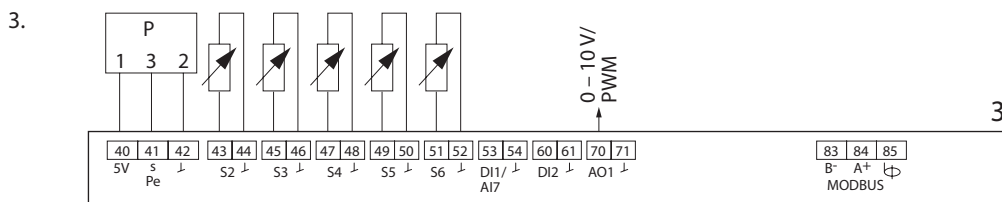
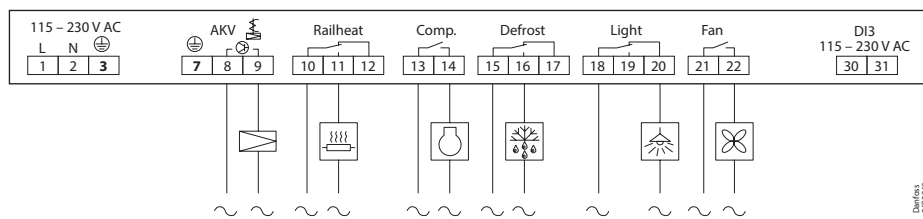
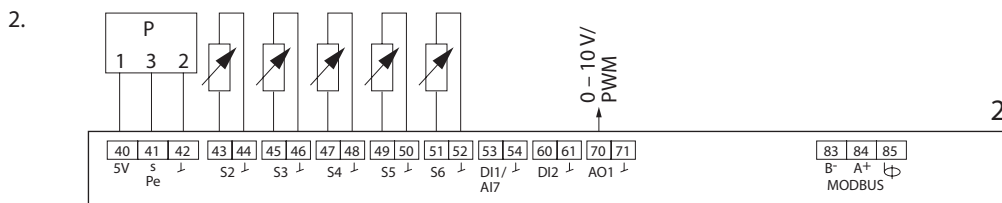
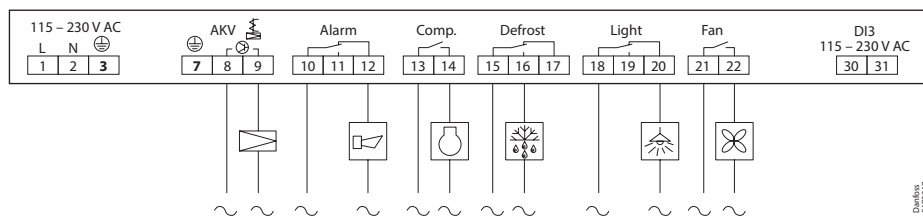
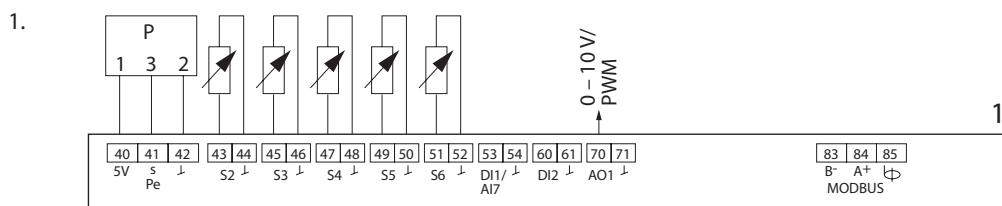

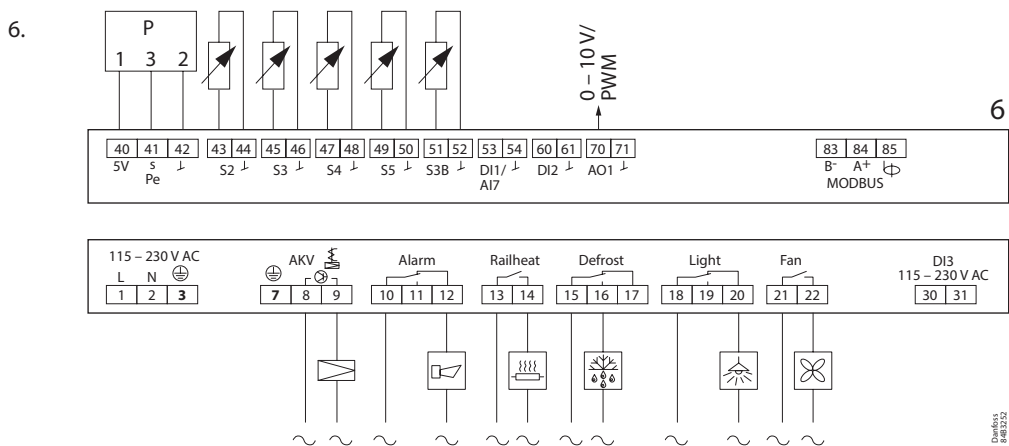
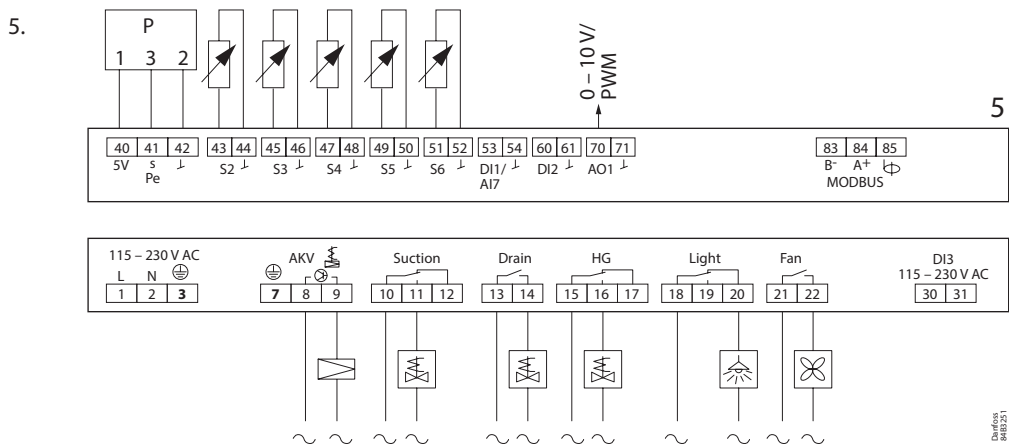
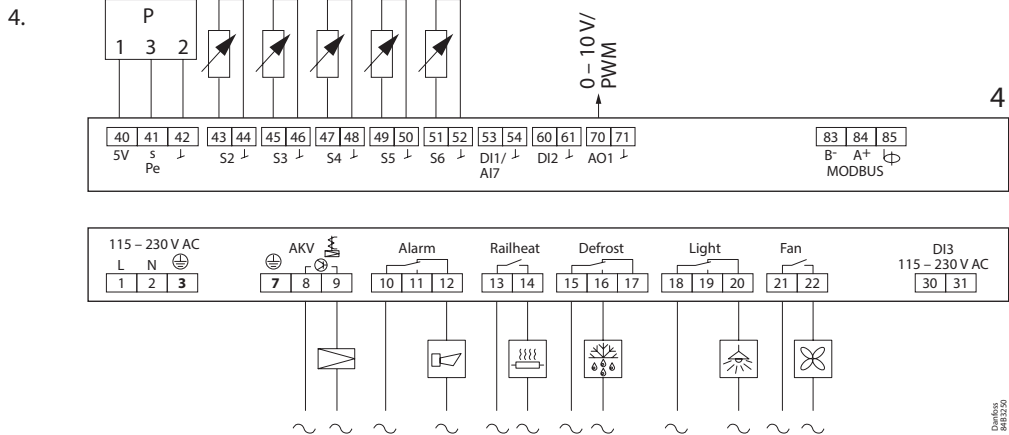

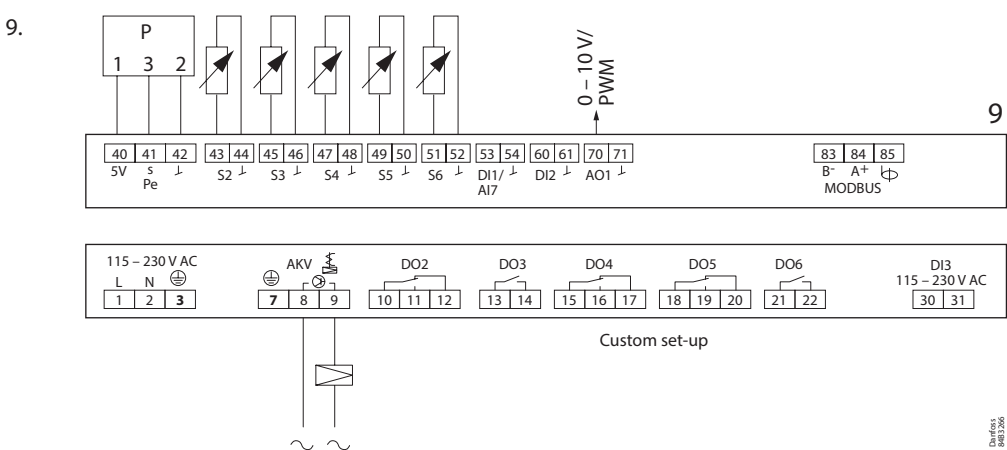
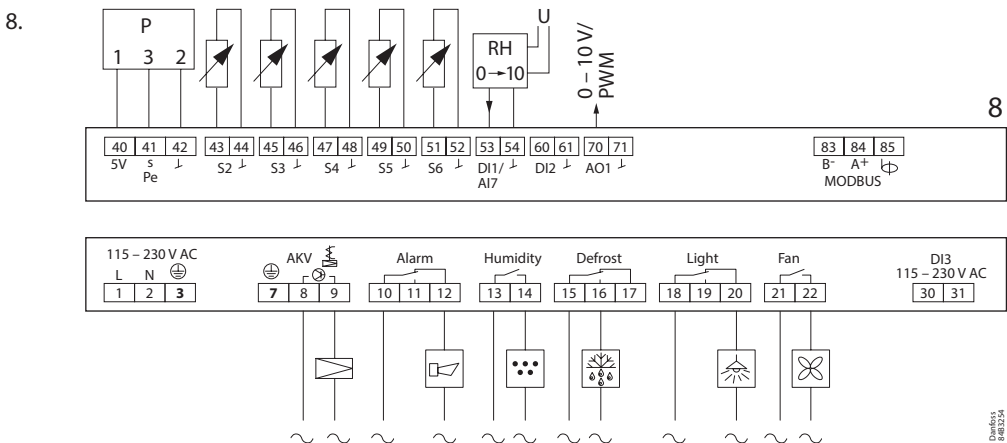
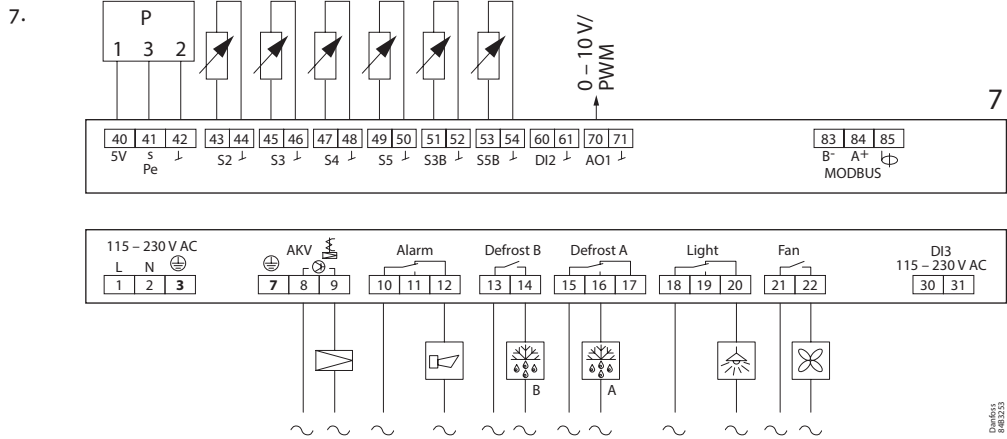

Data communication

Important

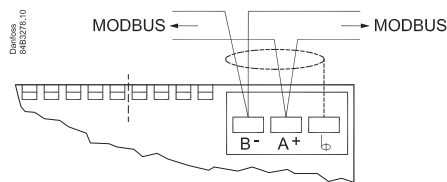

It is **important** that the installation of the data communication cable is performed correctly with sufficient distance to high voltage cables.

AKV info

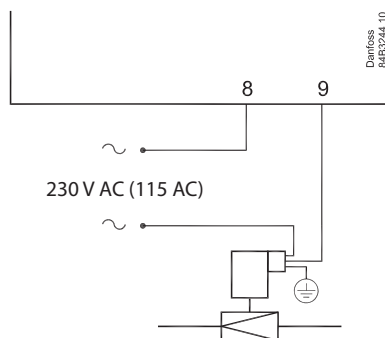

230 V or 115 V
AC coil
Max. 0.5 A

AKS 32R info

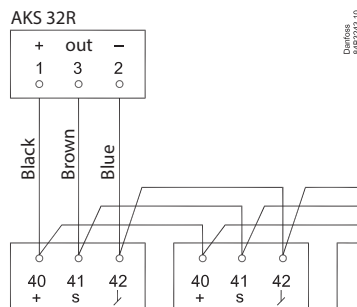

The signal from one pressure transmitter can be received by up to 10 controllers. There must not be a significant pressure drop from the pressure transmitter's position in the suction line to the individual evaporators.

Coordinated defrost via cable connections

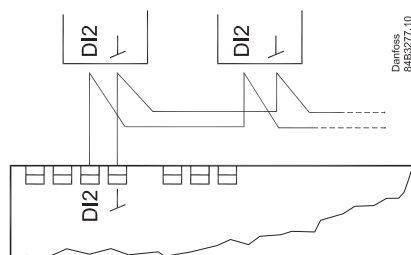

Max. 10

The following controllers can be connected in this way:
EKC 204A, AK-CC 210, AK-CC 250, AK-CC 450, AK-CC 550 and AK-CC55.

Refrigeration is resumed at the same time when all controllers have terminated defrost.

External display AK-UI55

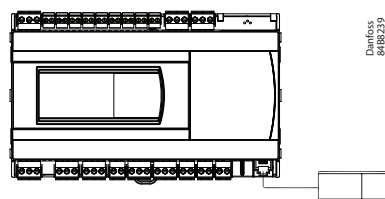

Display
084B4075 / 084B4076 / 084B4077

Cable 3 m: 084B4078
Cable 6 m: 084B4079
(L: Max. 100 m)

Technical data

Electrical specifications

Electrical data	Value
Supply voltage AC [V]	115 V / 230 V, 50/60 Hz
Power consumption [VA]	5 VA
Power ON indicator	Green LED
Electrical cable dimensioning [mm ²]	Max. 1.5 mm ² multi-core cable

Sensor and measuring data

Sensor and measuring data	Value
Sensor S2, S6	Pt 1000 AKS11
Sensor S3, S4, S5	Pt 1000 AKS11 PTC 1000 EKS111 NTC5K EKS211 NTC10K EKS221 sensor (All 3 must be of the same type)
Temperature measuring accuracy	Pt1000: -60 – 120 °C. ±0.5 K PTC1000: -60 – 80 °C. ±0.5 K NTC5K: -40 – 80 °C. ±1.0 K NTC10K: -40 – 120 °C. ±1.0 K
Pt1000 sensor specification	±0.3 K at 0 °C ±0.005 K per degree
Pe measuring	AKS 32R Ratiometric pressure transmitter: 10 – 90%
RH measuring	0 – 10 V Ri > 10K ohm Accuracy +/- 0,3% FS

Input and output relay specifications

Input and output relay specifications	Input/output	Description
Digital input	DI1 DI2	Signal from dry contact functions Requirements to contacts: Gold plating Cable length must be max. 15 m Use auxiliary relays when the cable is longer Open loop: 12 V (SELV) Contact 3.5 mA
Digital input	DI3	115 V / 230 V AC
Solid state output	DO1 (for AKV coil)	115V / 230 V AC Max. 0.5 A Max. 1 x 20 W AKV for 115 V AC 2 x 20 W AKV for 230 V AC Note: 2 EC coils are not supported.
Relays	DO2 DO3 DO4 DO5 DO6	115 V / 230 V AC Load max.: CE. 8 (6)A UL. 8A res. 3FLA 18LRA Load min.: 1VA Inrush: DO5 DO6 TV-5 80A
Analogue output/ PWM	AO1	0 / 10 V Pulse Width Modulated (PWM) max. 15 mA. 0 – 10 V variable, max. 2 mA

NOTE:

- DO2 to DO6 are 16 A relays.
- Max. load must be observed.
- DO5 / DO6 is recommended for load with high inrush current e.g. EC Fan and LED light.
- All relays are sealed for use with flammable refrigerant like Propane R290.
- Compliance with EN 60 335-2-89: 2010 Annex BB.

Function data

Function data	Value
Display	LED 3 digit
External display, AK-CC55 Single Coil UI	1 external display
External display, AK-CC55 Single Coil	2 external displays
External display connection	RJ12
Max. display cable length [m]	100 m
Data communication built-in	MODBUS
Data communication option	AK-OB55 Lon RS485 module (Not AK-CC55 Compact)
Clock battery backup power reserve	4 days
Mounting	DIN rail

Environmental conditions

Environmental conditions	Value
Ambient temperature range, operating [°C]	0 – 55 °C
Ambient temperature range, transport [°C]	-40 – 70 °C
Enclosure rating IP	IP20
Relative humidity range [%]	20 – 80%, non-condensing
Shocks/Vibrations	No shocks and vibrations allowed

Electric noise

Cables for sensors, low voltage DI inputs and data communication **must** be kept separate from other electric cables:

- Use separate cable trays
- Keep a distance between cables of at least 10 cm
- Long cables at the low voltage DI input should be avoided

Installation considerations

Accidental damage, poor installation, or site conditions, can give rise to malfunctions of the control system, and ultimately lead to a plant breakdown.

Every possible safeguard is incorporated into our products to prevent this. However, a wrong installation could still present problems. Electronic controls are no substitute for normal, good engineering practice.

Danfoss will not be responsible for any goods, or plant components, damaged as a result of the above defects. It is the installer's responsibility to check the installation thoroughly, and to fit the necessary safety devices.

Special reference is made to the necessity of signals to the controller when the compressor is stopped and to the need of liquid receivers before the compressors.

Your local Danfoss agent will be pleased to assist with further advice, etc.

Replacing AK-CC 550A with AK-CC55

Be aware when exchanging an AK-CC 550A controller with a new AK-CC55 controller - new wiring principles!

- Pressure sensor has new connection – signal and ground are switched

AK-CC 550A

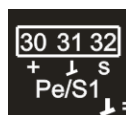

AK-CC55

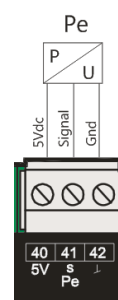

- SPDT relays have a new wiring scheme – NO and NC terminals are switched (e.g. defrost heater on when it should be off)

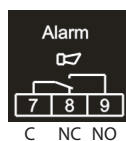

- Modbus has new connection scheme (A,B and screen)

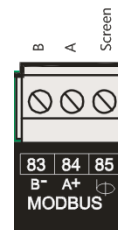
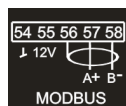

- New AK-UI55 displays and cables with 6 wires vs. 4 wires for EKA 16x



AK-CC55 does not support two EEC coils connected to one AKV output.

Pressure transmitter can be shared between AK-CC 550 and AK-CC55.

DI2 defrost coordination can be wired between AK-CC 550 and AK-CC55.

Operation with setting display

Display AK-UI55 Set

The values will be shown with three digits, and with a setting you can determine whether the temperature is to be shown in °C or in °F.

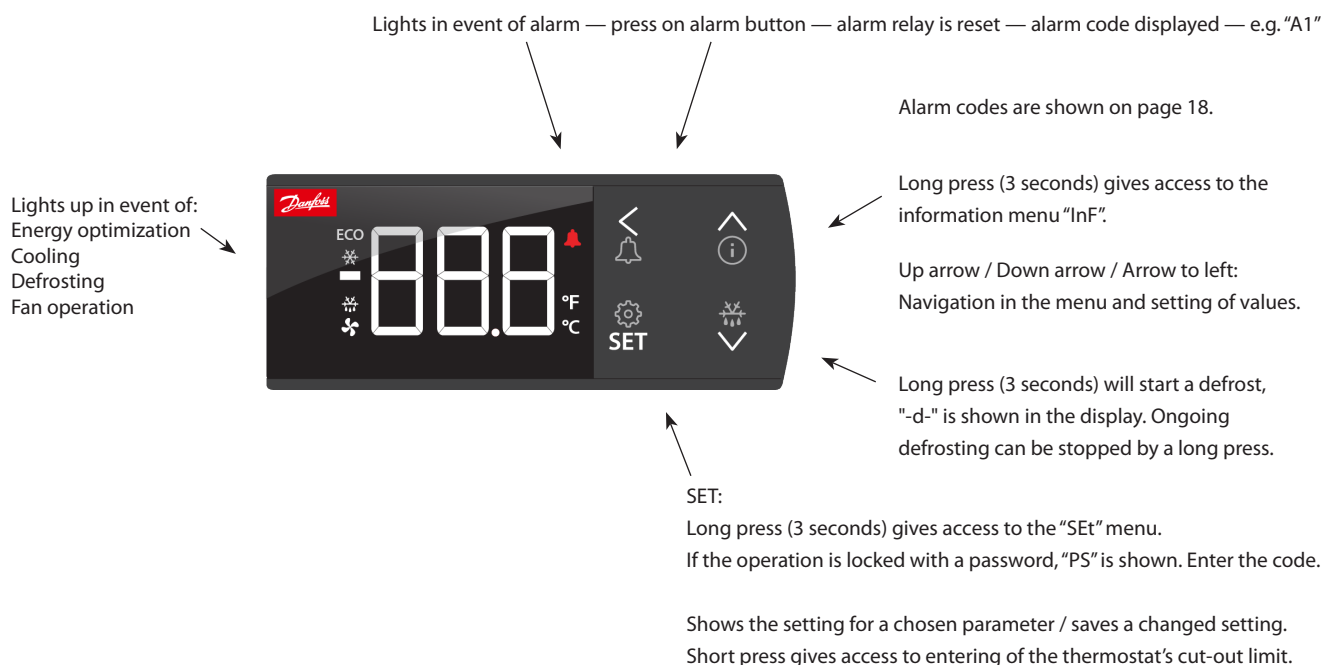

The display can give the following messages:

-d-	Defrost is in progress
Err	The temperature cannot be displayed due to a sensor error
Err1	The display cannot load data from the controller. Disconnect and then reconnect the display
Err2	Lost display communication
ALA	The alarm button is activated. The first alarm code is then shown
---	At top position of the menu or when max. value has been reached, the three dashes are shown in the top of the display
---	At bottom position of menu or when min. value has been reached, the three dashes are shown in the bottom of the display
Loc	The configuration is locked. Unlock by pressing (for 3 seconds) on the 'up arrow' and 'down arrow' simultaneously
UnL	The configuration is unlocked
---	The parameter has reached min. or max. limit
PS	A password is required for access to the menu
Fan	Appliance cleaning has been initiated. The fans are running
OFF	Appliance cleaning is activated and the appliance can now be cleaned
OFF	The main switch is set to Off
SEr	The main switch is set to service / manual operation
CO ₂	Flashes: Will display in event of a refrigerant leakage alarm, but only if the refrigerant is set up for CO ₂

Factory setting

If you need to return to the factory-set values, do the following:

- Cut off the supply voltage to the controller
- Keep up "∧" and down "∨" arrow buttons depressed at the same time as you reconnect the supply voltage
- When FAc is shown in the display, select "yes".

Parameter grouping at display operation

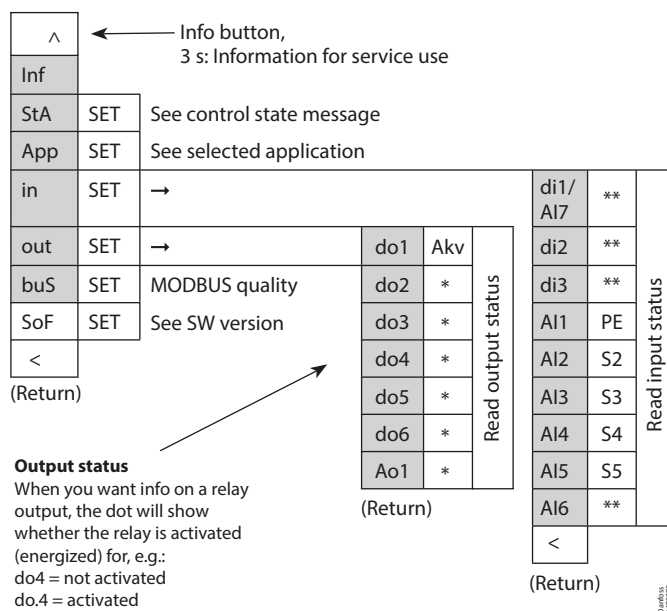
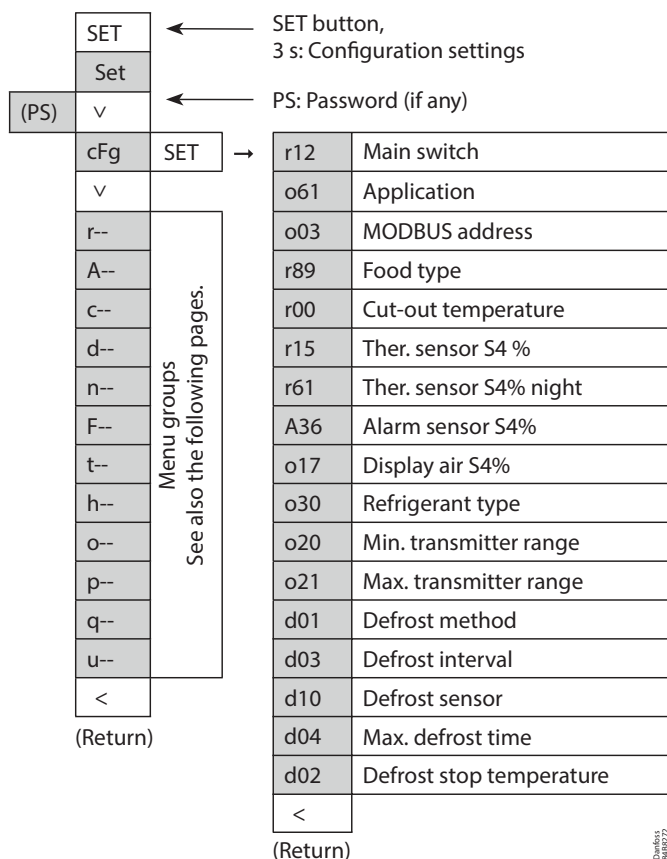

Output status
When you want info on a relay output, the dot will show whether the relay is activated (energized) for, e.g.:
do4 = not activated
do.4 = activated

*)
The output's function.
(Determined at configuration).
The DOs and AOs can also be forced controlled from this menu, when r12 Main switch has been set in position "service".
Forced control of a function can also be performed in codes q11 to q27.

**)
The input's function.
(Determined at configuration).

Get a good start

With the following procedure you can start regulation very quickly:

- Open parameter r12 and stop the regulation (in a new and not previously set unit, r12 will already be set to 0 which means stopped regulation)
- Select application based on the wiring diagrams on pages 2-4
- Open parameter o61 and set the application number
- For network. Set the address in o03
- Then select a set of presets from the "Food type" help table
- Open parameter r89 and set the number for the array of presets. The few selected settings will now be transferred to the menu
- Set the desired cut-out temperature r00
- Set the weighted thermostat air temperature between S4 and S3 sensor r15
- Set the weighted thermostat air temperature between S4 and S3 during night operation r61
- Set the weighted alarm air temperature between S4 and S3 A36
- Set the weighted display readout between S4 and S3 o17
- Select refrigerant via parameter o30
- Set the pressure transmitter min. and max. range via parameter o20 and o21
- Set the desired defrost method in d01
- Set the interval time between defrost starts in d03
- Set the desired defrost sensor in d10

- Set the maximum defrost time in d04
- Set the defrost stop temperature in d02
- Open parameter r12 and start the regulation
- Go through the parameter list and change the factory values where needed.
- Get the controller up and running on network:
 - MODBUS: Activate scan function in system unit
 - If another data communication card is used in the controller:
 - Lon RS485: Activate the function o04
 - Ethernet: Use the MAC address

Food type

Setting of presets (r89). After setting 1-5, setting is returned to 0.	1	2	3	4	5
Food type =	Vegetables	Milk	Meat/fish	Frozen food	Ice cream
Temperature (r00)	8 °C	0 °C	-2 °C	-20 °C	-24 °C
Max. temp. setting (r02)	10 °C	4 °C	2 °C	-16 °C	-20 °C
Min. temp. setting (r03)	4 °C	-4 °C	-6 °C	-24 °C	-28 °C
Upper alarm limit (A13)	14 °C	8 °C	8 °C	-15 °C	-15 °C
Lower alarm limit (A14)	0 °C	-5 °C	-5 °C	-30 °C	-30 °C
Upper alarm limit for S6 (A22)	14 °C	8 °C	8 °C	-15 °C	-15 °C
Lower alarm limit for S6 (A23)	0 °C	-5 °C	-5 °C	-30 °C	-30 °C

Fault message		
In an error situation the alarm LED on the front will be on and the alarm relay will be activated (depending on priority). If you push the alarm button for 3 seconds you can see the alarm report in the display. (Alarm priorities can be changed. See the User Guide.) Here are the messages that may appear:		
Code	Alarm text	Description
E01	Hardware failure	The controller has a hardware failure
E06	Clock lost time	Clock has lost valid time
E20	Pe Evap. pressure A - Sensor error	Sensor signal is out of range. Please check the sensor for correct operation
E24	S2 Gas outlet A - Sensor error	Sensor signal is out of range. Please check the sensor for correct operation
E25	S3 Air ON evap. A - Sensor error	Sensor signal is out of range. Please check the sensor for correct operation
E26	S4 Air OFF evap. A - Sensor error	Sensor signal is out of range. Please check the sensor for correct operation
E27	S5 Evaporator A - Sensor error	Sensor signal is out of range. Please check the sensor for correct operation
E28	S6 product temp. A - Sensor error	Sensor signal is out of range. Please check the sensor for correct operation
E34	S3 Air ON evap. B - Sensor error	Sensor signal is out of range. Please check the sensor for correct operation
E37	S5 Evaporator B - Sensor error	Sensor signal is out of range. Please check the sensor for correct operation
E59	Humidity sensor - Sensor error	Sensor signal is out of range. Please check the sensor for correct operation
A01	High temperature alarm A	The alarm temperature has been above the max alarm limit for a longer time period than the set alarm delay.
A02	Low temperature alarm A	The alarm temperature has been below the min alarm limit for a longer time period than the set alarm delay.
A04	Door open alarm	The door has been open for a too long time
A05	Max defrost hold time exceeded	The controller has been waiting longer time than permitted after a co-ordinated defrost.
A11	Refrigerant not selected	The refrigerant has not been selected hence control can not be initiated
A13	S6 high product temperature A	The S6 Product temperature has been above the max alarm limit for a longer time period than the set alarm delay.
A14	S6 low product temperature A	The S6 Product temperature has been below the min alarm limit for a longer time period than the set alarm delay.
A15	DI alarm 1	Alarm signal from digital input signal
A16	DI alarm 2	Alarm signal from digital input signal
A45	Main switch set OFF	The controller main switch has been set to either Stop or Manual control. Alternatively a digital input set up for "main switch" function, has stopped control
A59	Case in cleaning mode	A case cleaning operation has been started on a case
A70	High temperature alarm B	The alarm temperature has been above the max alarm limit for a longer time period than the set alarm delay.
A71	Low temperature alarm B	The alarm temperature has been below the min alarm limit for a longer time period than the set alarm delay.
AA2	CO2 leak detected	CO2 is leaking from the refrigeration system
AA3	Refrigerant leak detected	Refrigerant is leaking from the refrigeration system
a02	High humidity alarm	The humidity level is too high
a03	Low humidity alarm	The humidity level is too low
a04	Wrong IO configuration	Inputs and outputs have not been configured correctly
X02	Evaporator is icing up	The adaptive defrost function has detected heavy ice formation on evaporator.
X03	Flash gas detected	The adaptive defrost function has detected heavy flash gas in front of injection valve
Z01	Max defrost time exceeded A	The last defrost cycle has stopped on time instead of set temperature
A34	Fan alarm	Alarm from digital input monitoring function
A43	Valve driver alarm	Alarm from digital input monitoring function
Data communication: The importance of individual alarms can be defined with a setting. The setting must be carried out in the group "Alarm destinations"		

Additional information not relevant for safe installation and use can be found on Danfoss Store:



For more detailed information, please see the respective User Guide.

Danfoss A/S

Climate Solutions • danfoss.com • +45 7488 2222

Any information, including, but not limited to information on selection of product, its application or use, product design, weight, dimensions, capacity or any other technical data in product manuals, catalogues descriptions, advertisements, etc. and whether made available in writing, orally, electronically, online or via download, shall be considered informative, and is only binding if and to the extent, explicit reference is made in a quotation or order confirmation. Danfoss cannot accept any responsibility for possible errors in catalogues, brochures, videos and other material. Danfoss reserves the right to alter its products without notice. This also applies to products ordered but not delivered provided that such alterations can be made without changes to form, fit or function of the product.

All trademarks in this material are property of Danfoss A/S or Danfoss group companies. Danfoss and the Danfoss logo are trademarks of Danfoss A/S. All rights reserved.